

Hybrid Beamforming for Millimeter Wave Massive MIMO using Singular value Decomposition

Antoun Elias Francis¹

¹Department of Electronics and Telecommunication Engineering, Damascus University-Damascus - Syria

Abstract— Beamforming is an essential process in 5G networks and beyond, with the aim of overcoming the obstacles resulting from the adoption of millimeter waves to transmit data, which suffer from large path loss and are affected by various obstacles. Also, in order to deal with these characteristics, a large number of (Massive MIMO) antennas must be adopted, which makes it difficult to rely on digital beamforming due to the energy constraints resulting from the necessity of having a radio chain for each antenna, which has pushed towards developing hybrid beamforming algorithms.

In this paper, we will study the performance of hybrid beamforming based on the Singular value Decomposition (SVD) method, in terms of spectrum efficiency and bit error rate compared with full digital beamforming case, and we will study the effect of increasing the number of transmitter and receiver antenna and the number of RF chains.

Index Terms—5G, Millimeter waves, Massive MIMO, Hybrid beamforming, SVD, RF chains.

I. INTRODUCTION

Millimeter waves are considered the physical layer for data transmission in fifth generation networks in order to achieve high data transfer rates, whereas wireless communication systems depend on spectral efficiency (SE) and bandwidth to achieve the increasing demand. Since all communications technologies operate on frequencies within the 300MHz and 3GHz range (Andrews et al, 2014), and since the physical layer technology used has reached Shannon's capacity (Bangertner et al, 2014), the only option is to increase the system's bandwidth by using the high-frequency millimeter wave range between 30 GHz and 300 GHz, which is the core of the 5G wireless networks (Irfan et al, 2018).

Using Millimeter waves promoted to use multiple-input-multiple-output (MIMO) technology (multiple antennas at transmitter (TX) and receiver (RX)), to improve SE by:

- 1) The base-station (BS) can communicate with multiple user equipment (UEs) on the same time-frequency space resources
- 2) Multiple data streams are possible between the BS and each UE.

Massive MIMO can help in the reduction of small-scale fading and required transmission energy due to beamforming

gain. In addition, massive MIMO is essential for mmWave frequencies because it exploits beamforming gain for obtaining sufficient signal-to-noise-ratio (SNR) by combating high pathlosses (Irfan et al, 2018).

But the big problems that millimeter wave technology suffers from, such as path loss, fading, and its inability to propagate well in most materials will lead to the use of a large number of antennas in a small area, which means a large energy consumption, and thus the inability to implement this method in practice. In addition, the traditional microwave signal processing with a limited number of antennas, can be easily done in the digital domain. But with massive MIMO techniques, digital beamforming cannot be used, and we need a special Radio frequency (RF) chain for each antenna, which means high cost, high complexity and high power consumption. All of this imposed a new way of beamforming, which is hybrid beamforming, to reduce frequency chains with using large number of antennas (Irfan et al, 2018).

II. AIM OF THE RESEARCH:

studying the performance of the mechanism of hybrid beamforming (HBF) based on the Singular value Decomposition (SVD) method in the fifth generation (5G) networks and comparing it with the case of full digital beamforming (FD).

III. HYBRID BEAMFORMING:

Without using hybrid beamforming, we cannot use Millimeter wave and massive MIMO technique, because using digital beamforming only will be very expensive and complicated, and using analog beamforming only will increase inaccuracy and interference between users, fig 1 shown the Beamforming architectures in mmWave massive MIMO systems.

The use of hybrid beamforming will obviously increase the energy efficiency as it reduces the transmission power of the downlink and uplink through the coherent multiplexing mechanism and increases the antenna radiation area. We can increase the energy efficiency of the uplink by limiting the transmission power required for each user device (UE), which is inversely proportional to the number of antennas in the BS

with no decrease in performance Increasing the number of antennas allows using low-cost m Watt RF amplifiers, where

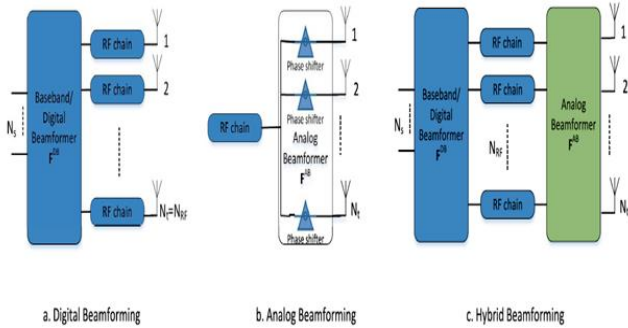

Fig 1 : Beamforming architectures in mmWave massive MIMO systems: (a) Fully-digital architecture, (b) Analog only architecture, (c) Hybrid analog/digital architecture (Irfan et al,2018).

the total transmitted power is directly proportional to $1/N_t$ where N_t is the number of transmitting antennas. There are two type of hybrid beamforming, the first is full connected and the second is sub_ connected. In the first one, each RF chain is connected to the total antennas, while in the second , each RF is connected to a sub-array of the total antenna array as shown in fig 2.

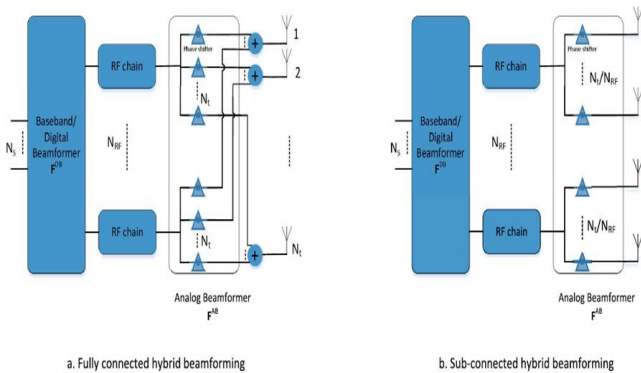

Fig 2: Major types of hybrid beamforming: (a) Fully-connected hybrid beamforming, (b) Sub-connected hybrid beamforming (Irfan et al,2018).

hybrid beamforming contains two stages, the digital beamforming, in which the weight parameters are determined according to one of the precoding techniques used to beamforming in MIMO systems, then the RF radio series stage, which consists of a group of electronic equipment such as the ADC converter from digital to analog, and finally the analogue beamforming stage, where the analogue beamforming mechanism can be implemented either via digitally controlled phase shifts or via switches or leans antenna.

The advantage of using digitally controlled phase shifters is the possibility of digital beamforming with correction of inaccuracy problem that occurs when using phase shifters which eliminates residual interference due to data streams, in

addition to obtain a high array gain, but it suffers from high power consumption and quantization error because the limitation of phase shifts. In another hand analog beamforming via switches is low-power, low-complexity, but low-gain matrix compared to phase-shifters (Wang.J et al, 2016)

The digital beamforming process is implemented by adopting one of the traditional beamforming algorithms in MIMO with adjusting the parameters to suit the restrictions imposed by analogue beamforming. In our research, we will use the Single Value Decomposition method (SVD) to achieve digital beamforming.

IV. HYBRID BEAMFORMING BASED ON THE SINGULAR VALUE DECOMPOSITION (SVD)METHOD:

Digital beamforming will be executed first, where the data will pass through the Baseband precoder F_{BB} consisting of $N_s * N_t^{RF}$ array, then the encoded data strings are converted to the radio field to complete the process of analogue beamforming F_{RF} composed of the $N_t * N_t^{RF}$ array of weights. So the total encoder array will be $F = F_{BB} * F_{RF}$.

Assuming, we have a transmitter with N_t antennas and N_t^{RF} radio chain (Rf). And in the receiving section we have a receiver with a number N_r of antennas and N_r^{RF} of radio chain (RF).

The coefficients of the digital precoding change with amplitude and phase, but the analogue beamforming coefficients have constant amplitude and phase change only, where the value of amplitude is $1/(\sqrt{N_t})$ in case of using phase shifter.

The sent signal can be modeled as in (1):

$$X = F.S \quad (1)$$

Where S is the beam of data sent codes which is of length $(1 * N_s)$, they are independent codes for each user and have a unit power, where:

$$E[S_i S_j^*] = 0, i \neq j \quad \& \quad E[S_i S_i^*] = 1/(\sqrt{N_t}) \quad (2)$$

The received signal is given by the relation:

$$y_i = H_x + n = HFS + n \quad (3)$$

Where H is the transmission line between $B S_i$ and $U E_i$ and n the Gaussian noise.

Then the receiver adjust the incoming signal using digital combiner W_{BB} and analog combiner W_{RF} , so the final combiner array is $W_i = W_{BB} W_{RF}$, where the received signal processed ,so will get the beam of estimated data by (4) (Nguyen,2017) :

$$\hat{S} = W^H HFS + W_i^H n_i \quad (4)$$

The Millimeter wireless channel (H) is described according to (5)(Vutha. Et al,2016):

$$H = \frac{1}{\sqrt{N_p}} \sum_{ncl}^{Ncl} \sum_p^{Np} \rho_{ncl} g_{ncl,p}(t) \cdot \alpha_{ncl,p}^{Rx}(\alpha_{ncl,p}^{Rx}, \theta_{ncl,p}^{Rx}) \cdot \alpha_{ncl}^{Tx}(\alpha_{ncl}^{Tx}, \theta_{ncl,p}^{Tx})^H \quad (5)$$

Where:

N_{cl} number of clusters, N_p number of paths into the cluster, ρ_{ncl} partial power of cluster, $g_{ncl,p}(t)$ the complex gain of narrow band fading channel.

$\alpha_{ncl,p}^{Rx}(\alpha_{ncl,p}^{Rx}, \theta_{ncl,p}^{Rx})$ the response function of the 3D transmitter array, $\alpha_{ncl}^{Tx}(\alpha_{ncl}^{Tx}, \theta_{ncl,p}^{Tx})$ the response function of the 3D receiver array, so will get an array by N_r rows and N_t columns.

In our paper will use a uniform planer transmitter and receiver antenna array which support us in 3D- beamforming.

Will use a network of phase shifters when executing the analog beamforming, so all the values of the array has a constant amplitude equal to $1 / (\sqrt{N_t})$ in transmit case, and $1 / (\sqrt{N_r})$ in receive case.

Where the beam of analog beamforming array FRF given by (6):

$$F_{RF} = [w^{\{0,0\}}, \dots, \dots, w^{\{n-1,m-1\}}] \quad (6)$$

The parameters of analog beamforming array chosen from CodeBook. The parameters of this codebook predefined for a number of angles cover a number of probabilities depending on the accuracy of the codebook, where the codebook is a group of beams and we can called (Code Word)each coded word contains a set of phase shifts that will apply to all antenna elements. The result of using codebook is increase the array gain in a specific direction, and for 3D-beamforming the codebook support array gain in both θ and φ angle.

Assuming F is the our codebook so the number of beams is $2^{N_\theta N_\varphi}$ where N_θ the number of θ angles, and N_φ the number of φ angles, then the form of codebook beams is:

$$\alpha_t \left(\frac{2\pi K_\varphi}{2^{N_\varphi}}, \frac{2\pi K_\theta}{2^{N_\theta}} \right)$$

Where K_φ take values from 0 to $2^{N_\varphi} - 1$, and N_θ from 0 to $2^{N_\theta} - 1$ (El Ayach.O et al,2014)

After sending a signal for each CodeWord by main station, the receiver will choose a couple from CodeWord to enlarge the received gain (El Ayach.O et al,2014):

$$(F_{RF}, W_{RE}) = \arg \max |W_{RE} * H F_{RF}| \quad (7)$$

$$W_{RE}, F_{RF} \in F$$

After defining the specific coefficients pairs of analog beamforming array by user at both transmitter and receiver, now will determine the coefficients of digital beamforming by

using the Singular value Decomposition (SVD) according to the following:

- formation of the Effective Baseband Channel after chosen the coefficients of linear beamforming (El Ayach.O et al,2014):

$$H_{effi} = W_{RFi} * H_i F_{RFi} = \sqrt{N_t N_r} g_i(t) W_{RFi} F_{RFi} \quad (8)$$

- Analysis of SVD for active array channel (Peken.t et al,2020):

$$H_{effi} = UAV^H \quad (9)$$

Where U, V a monolithic array, and A is a diagonal array with a unity value.

- Now for grating the transferred data and stopping the interference the digital encoder using SVD given by (Li.M et al, 2017):

$$FBB = V \text{ and } WBB = U \quad (10)$$

But this coefficient values of digital beamforming must controlled to suit the coefficient of precoding power, because ther are tow beamforming stage, analog and digital, so the following condition must happen:

$$\|F_{RF} F_{BB}\|_F^2 = N_s$$

$$\|W_{RF} W_{BB}\|_F^2 = N_s$$

So the coefficients of precoding and digital beamforming should be set as:

$$F_{BB} = \frac{VN_s}{\|F_{RF} F_{BB}\|_F^2}$$

$$W_{RF} = \frac{UN_s}{\|W_{RF} W_{BB}\|_F^2}$$

V. PRACTICAL PART:

The performance of the proposed system (hybrid beamforming based on the Singular value Decomposition method) has been studied, in terms of bit error rate and spectrum efficiency compared with full digital beamforming case.

First we implemented the study for $N = 64$ antennas for each of the transmitter and receiver with changing the number of RF chains. Fig3 shows the Bit Error Rate for Hybrid beamforming and full digital beamforming for $NRF = 2$, where it resulted that the bit error rate for full digital is better than the case of Hybrid at height noise rates ($SNR = -35:-15$), but with the improvement of the signal to noise ratio the performance of both become convergent.

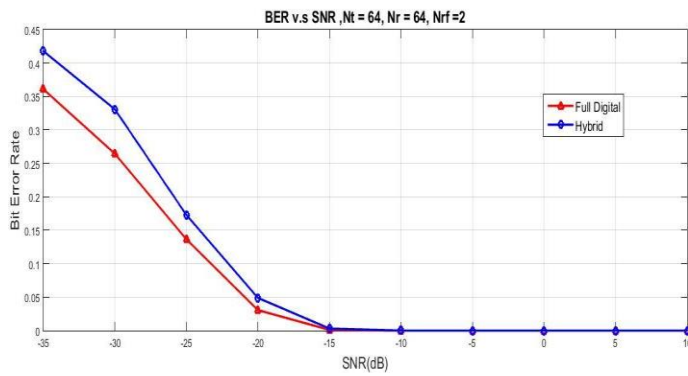

Fig 3: BER V.S SNR for Full digital and Hybrid beamforming for N =64 antennas and NRF = 2

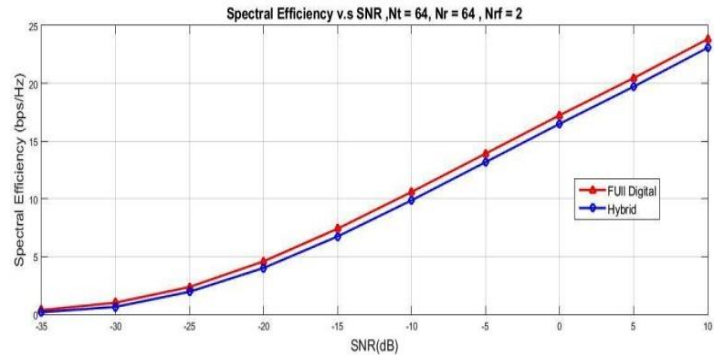

Fig 6: BER V.S SNR for Full digital and Hybrid beamforming for N =64 antennas and NRF = 2

By increasing the RF chains to 4 as shown in Fig 4 and then to 8 as shown in Fig5 we noticed decrease the bit error rate for the Hybrid case and became closer to Full digital case at high noise level.

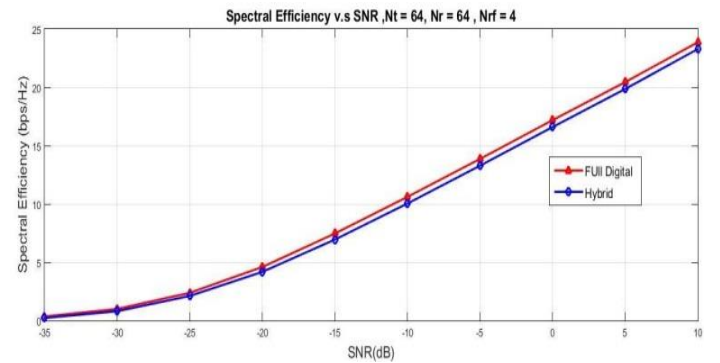

Fig 7: BER V.S SNR for Full digital and Hybrid beamforming for N =64 antennas and NRF = 4

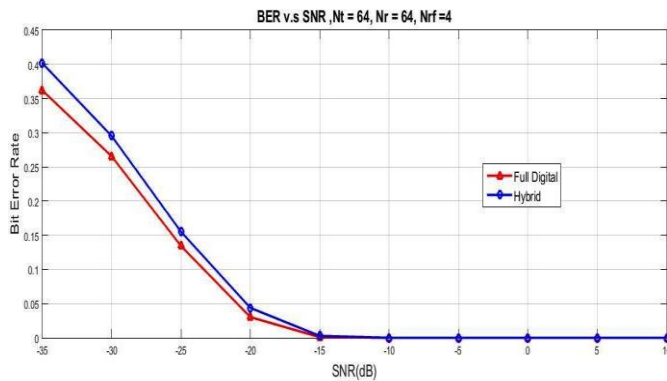

Fig 4: BER V.S SNR for Full digital and Hybrid beamforming for N =64 antennas and NRF = 4

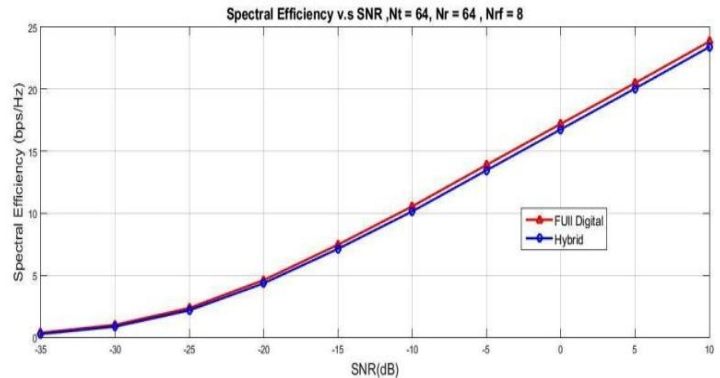

Fig 8: BER V.S SNR for Full digital and Hybrid beamforming for N =64 antennas and NRF = 8

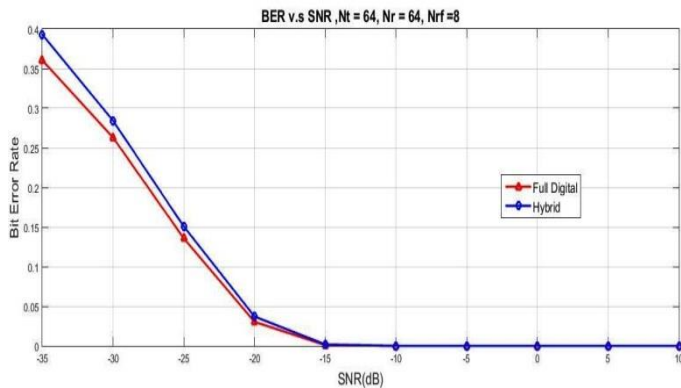

Fig 5: BER V.S SNR for Full digital and Hybrid beamforming for N =64 antennas and NRF = 8

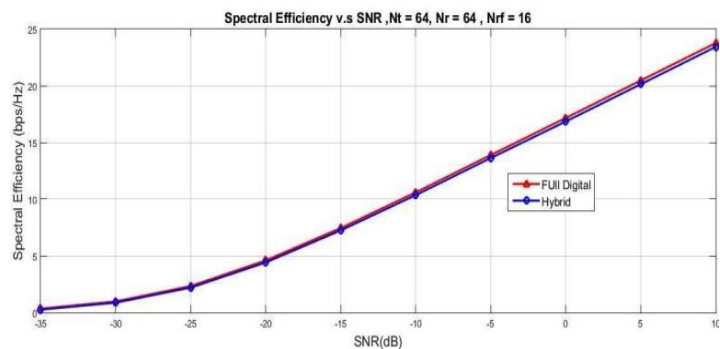

Fig 9: Spectral Efficiency V.S SNR for Full digital and Hybrid beamforming for N =64 antennas and NRF = 16

In figs(6,7,8,9) that the spectral efficiency of Full digital and Hybrid beamforming became more closer when the number of RF chains increase.

For $N = 128$, we noticed that the bit error rate with high noise level became lower (0.38) when $SNR = -35$ for Hybrid beamforming as shown in Fig10, comparing with (0.425) at $SNR = -35$ in case $N=64$, and as in first step the performance of Full digital and Hybrid beamforming became closer when the RF chain increased as shown in Fig. 11.

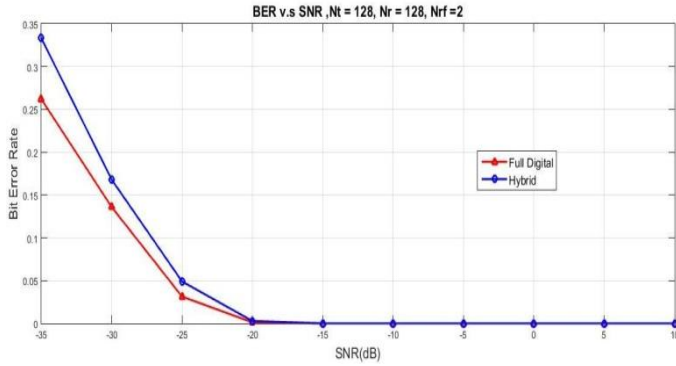

Fig 10: BER V.S SNR for Full digital and Hybrid beamforming for $N = 128$ antennas and $NRF = 2$

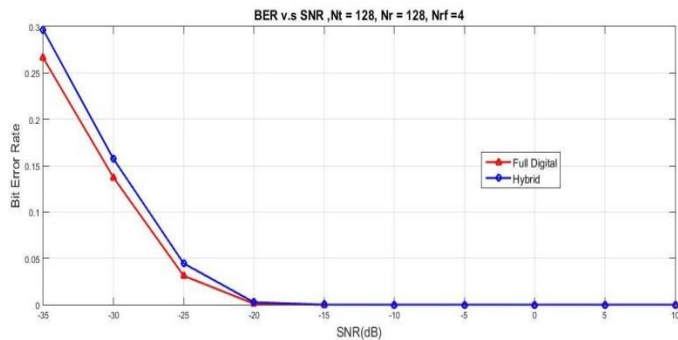

Fig 11: BER V.S SNR for Full digital and Hybrid beamforming for $N = 128$ antennas and $NRF = 4$

Fig.12 shown the Spectral efficiency of Full digital and Hybrid beamforming for $N=128$ which it increased compering with $N=64$. And the tow line became closer when the number of RF chains increased as shown in Fig.13.

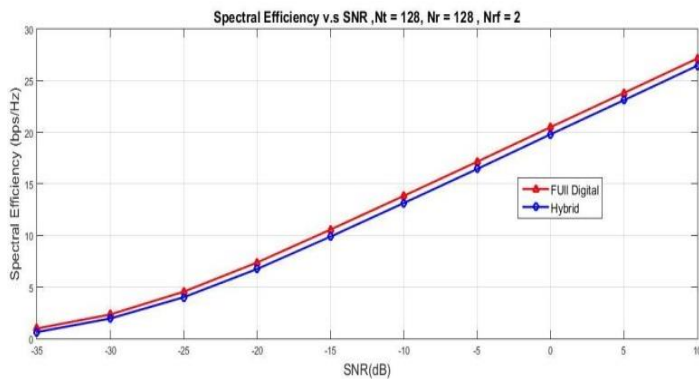

Fig 12: Spectral Efficiency V.S SNR for Full digital and Hybrid beamforming for $N = 128$ antennas and $NRF = 2$

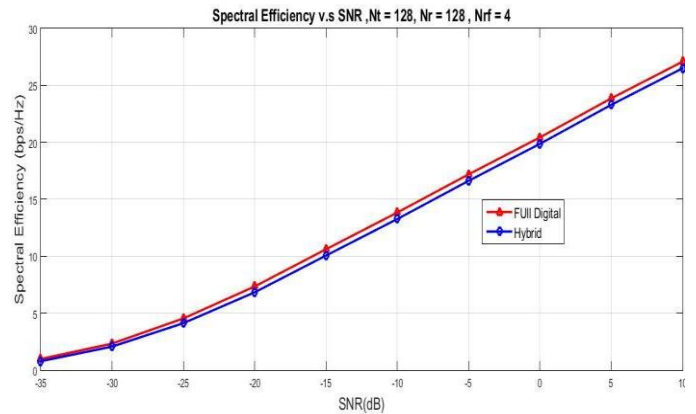

Fig 13: Spectral Efficiency V.S SNR for Full digital and Hybrid beamforming for $N = 128$ antennas and $NRF = 4$

For $N=256$ the bit Error rate became about 0.16 for Hybrid beamforming with RF chains = 2 as shown in Fig14. And the spectral efficiency increased too as shown in Fig15.

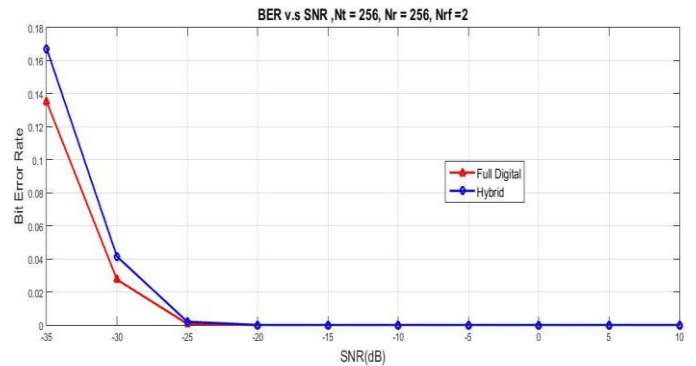

Fig 14: BER V.S SNR for Full digital and Hybrid beamforming for $N = 128$ antennas and $NRF = 2$

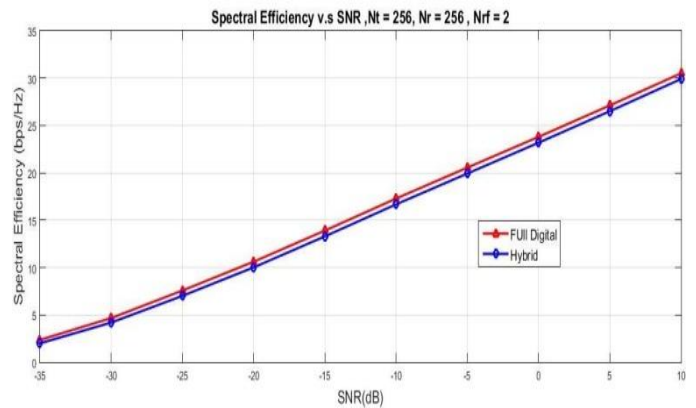

Fig 15: Spectral Efficiency V.S SNR for Full digital and Hybrid beamforming for $N = 128$ antennas and $NRF = 2$

CONCLUSION

In this paper, we studied the performance of hybrid beamforming based on the Singular value Decomposition method, compared with full digital beamforming case, and we studied the effect of increasing the number of transmitter and receiver antenna and the number of RF chains, we found that:

- 1- Hybrid beamforming using SVD gave us a bit error rate and spectrum efficiency closer to full digital beamforming
- 2- The bit error rate decreased and the spectrum efficiency increased by using a large number of antenna(BER = 0.16 at SNR=-35, N=256) so we get great performance from Hybrid beamforming without increase the number of RF chains and without increase power consumption.
- 3- By increasing the number of RF chains the performance of Hybrid and Full digital methods became closer.

. REFERENCES

- Andrews,J.G, Buzzi,S, Choi,W, Hanly, S. V, Lozano,A, Soong, A. C. K & Zhang, J. C.(2014). What Will 5G Be?, *vol. 32, no. 6, pp. 1065-1082*
- Bangerter,B, Talwar, S, Arefi, R, & Stewart, K,(2014), Networks and devices for the 5G era, *IEEE Commun. Mag., vol. 52, no. 2, pp. 90–96.*
- Cotelo.M.M, Valcarce.L.R.,(2021), Design of hybrid beamformers for full-duplex MMwave transceivers, *Master's thesis, Vigo University.*
- El Ayach.O et al,(Mar. 2014), Spatially Sparse Precoding in Millimeter Wave MIMO Systems, *IEEE Trans. Wireless Commun., vol. 13, no. 3, pp.1499–1513.*
- Irfan. A, Hedi. K, Adnan. S, Ahmed. M, Kwang.S. K, Eli.D. P,& Ingrid.M, (Fourth Quarter 2018),A Survey on Hybrid Beamforming Techniques in 5G: Architecture and System Model Perspectives, *IEEE Communications Surveys & Tutorials, Vol. 20, No. 4.*
- Li.M, Wang.Z, Tian.X and Liu.Q,(2017), Joint hybrid precoder and combiner design for multi-stream transmission in mmWave MIMO systems, *in IET Communications, vol. 11, no. 17, pp. 2596-2604.*
- Nguyen.D. H. N, Le. L. B & Le-Ngoc.T,(2017),Hybrid MMSE precoding for mmWave multiuser MIMO systems, *IEEE Int. Conf. Commun., Kuala Lumpur, Malaysia, pp. 1–6.*
- Peken.t, Adiga.S, Tandon.R, and Bose.T,(2020), Deep Learning for SVD and Hybrid Beamforming, *Department of Electrical and Computer Engineering University of Arizona, Tucson, IEEE Transactions on Wireless Communications.*
- Vutha.V, Takayuki.S, Gaurav.B, Robert.W, Heath.J,(2016) , Millimeter Wave Vehicular Communications: A Survey, *in Millimeter Wave Vehicular Communications: A Survey.*
- Wang.J et al,(2016), Scalable Beamforming for 11ay, *IEEE 802.11 Documents*.Jan. Retrieved from: https://mentor.ieee.org/802.11/documents?is_dcn=SSW&is_group=00ay